



OLFO - A



OLFO - B



FOLFO-C



OLFO - D

operation manual OLFO

Deep fryers / electronics

ENGLISH

Version 8.7

Thank you for choosing a Gastrofrit® product. Your product was made entirely in Switzerland. Your product has been subjected to a long-term test. Please note that incorrect commissioning can lead to damage. Before commissioning, check the exact requirements for power consumption, voltage and current to ensure that the device can be operated without any worries.

Table of contents

3	Models and variants
3	Installation and setting up
3	Power connection and technical information
4	Technical specifications
5	Support plate
6	Pressure filter
6	Keypad deep fryer
7	Operating
7	Call up the parameter menu
8	ABCD interface for Sicotronic EAM-N module:
9	Parameter Matrix
10	Top up with deep-frying oil Ablaufhahn.
10	Switching on the deep fryer
10	Programming the parameters
11	Frying
11	Reset
11	Oil filter system (Clean System)
11	Manually
12	Semi-automatic: pump / safety drain
12	Automatic oil filtration
12	Watch Volume with automatic
13	Automatic basket lift
13	Energy optimization
13	Service functions
13	Change O-rings Heater can be removed
13	Possible malfunctions
14	Machine has no function, display dark
14	Warning message Error 1, PT-100 / PT-1000
14	Maintenance and customer service
14	maintenance
14	cleaning
14	devices
15	Heating elements
16	Hazard warnings
16	Preventing, fighting oil fires
16	Moving deep fryers
16	Extended display
17	Tastenbelegung im Testmode
18	Test Pages:
19	DIP Switch / Connection scheme

Models and variants

OLFO - A	Item No. 103000	2 x 17 Lt. / 2 x 9 Lt.
OLFO - B	Item No. 103001	3 x 17 Lt.
OLFO - C	Item No. 103002	1 x 17 Lt. / 4 x 9 Lt.
OLFO - D	Item No. 100250	1 x 17 Lt. / keep warm area / 2 x 9 Lt.

Installation and setting up

Floor standing devices

When setting up the deep fryer, the following points must be observed:

- The distance from the rear wall of the deep fryer to the next wall must be at least 100 mm.
- The deep fryer must not stand on a flammable surface or be built into a flammable unit.
- The local safety, fire police and building regulations also apply.
- The requirements of the food inspectorate must also be observed.
- The deep fryer is a fixed device. The roles are only intended to facilitate maintenance and cleaning work. These can be removed by simply notching them as required. The device must not be moved during operation.
- The standard height of the device is 850mm. This can be increased to 900mm with a substructure as required.
- The power plug must be accessible after setting up the device.

Stability (standing devices)

Due to insufficient stability, the F-300 devices must not be set up freely.

Power connection and technical information

- The device may only be connected by trained specialists.
- After switching on the main switch, the device starts and an automatic calibration takes place.
- The software version (e.g. Gastro 8.67) can then be read on the display.
- The 3x400V (3L + N + PE) power connection is made with a standard-compliant CE plug. See Appendix 1



Version A

- 2 x 17 liter
- 2 x 9 liter



Version B

- 3 x 17 liter

Key data	Standard	Powerheater
Power:	2 x 7.2 kW und 2 x 14 kW	2 x 9.8 kW und 2 x 18 kW
Amps:	2x11 A + 2x21 A	2x15 A + 2x25 A
Volts:	4x3x400V,3PNE	4x3x400V,3PNE
Oil capacity:	52 liters	52 liters
Fryer baskets:	4 - 6	4 - 6
Hourly output	2 x 17 kg frozen fries/h 2 x 37 kg frozen fries/h	2 x 23 kg frozen fries/h 2 x 50 kg frozen fries/h

Key data	Standard	Powerheater
Power:	3 x 14 kW	3 x 18 kW
Amps:	3x21 A	2 x 26 A
Volts:	3 Stck. 3x400V,3PNE	4 Stck. 3x400V,3PNE
Oil capacity:	51 Lt	51 Lt
Fryer baskets:	3 - 6	3 - 6
Hourly output	3 x 37 kg frozen fries/h	3 x 50 kg frozen fries/h



Version C

- 1 x 17 liter
- 4 x 9 liter



Version D

- 1 x 17 liter
- 2 x 9 liter
- Keep-warm area

Key data	Standard	Powerheater
Power:	4 x 7.2 kW und 1 x 14 kW	4 x 9.8 kW und 1 x 18 kW
Amps:	1x21A + 4x11A	1x26 A + 4x15 A
Volts:	5 Stck. 3x400V,3PNE	5 Stck. 3x400V,3PNE
Oil capacity:	53 Lt	53 Lt
Fryer baskets:	5 - 6	5 - 6
Hourly output	4 x 17 kg frozen fries/h 1 x 37 kg frozen fries/h	4 x 23 kg frozen fries/h 1 x 50 kg frozen fries/h

Key data	Standard	Powerheater
Power:	2 x 7.2 kW und 1 x 14 kW	2 x 9.8 kW und 1 x 18 kW / 1 x 1.1 kW
Amps:	1x21A + 2x11A	1x26A + 2x15A
Volts:	3x3x400V,3PNE 1x230 V,PNE	3x3x400V,3PNE 1x230 V,PNE
Oil capacity:	32 Lt	32 Lt
Fryer baskets:	3 - 4	3 - 4
Hourly output	2 x 17 kg frozen fries/h 1 x 37 kg frozen fries/h	2 x 23 kg frozen fries/h 1 x 50 kg frozen fries/h

- ☺ Plasma air cleaner
- ☺ Plug-in heater Option
- ☺ Watch Volume Option
- ☺ Automatic basket lift
- ☺ Oil-check system
- ☺ Automatic oil filtration
- ☺ Power heater
- ☺ Integrated fire extinguisher
- ☺ Integrated keep-warm area
- ☺ Energy optimization
- ☺ Service kit as a case for semi-professionals
- ☺ Service contract / Extended warranty
- ☺ Training / Service training

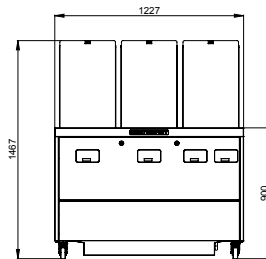

VORDERSEITE

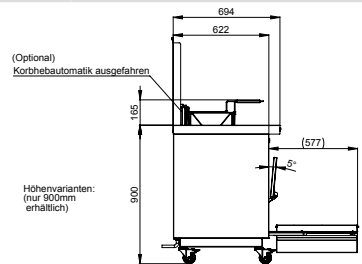

SEITENSICHT von LINKS

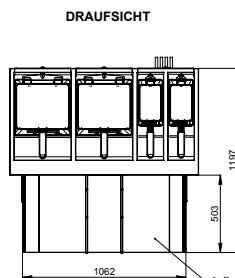

DRAUSICHT

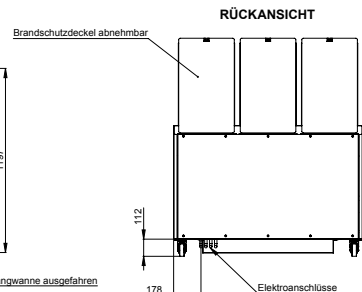

RÜCKANSICHT

Support plate

The support plate is located inside the service door and contains three security items.

1. Cone stopper (Item No. 305010.050): The cone stopper must be inserted so that no dirt can get into the heater lead through the plug-on heater. This allows the interior of the pans to be cleaned.
2. Protective cap (Item. No. 501000-812): Protection of the unplugged heater. The heater can be cleaned in the appliance or dishwasher.
3. O-ring (Item No. 503000.030): This seals the plug-in heater. The O-ring should be replaced every year.

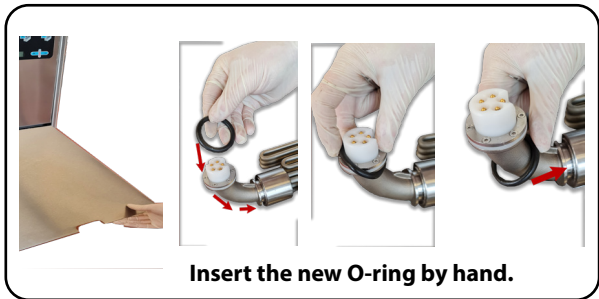
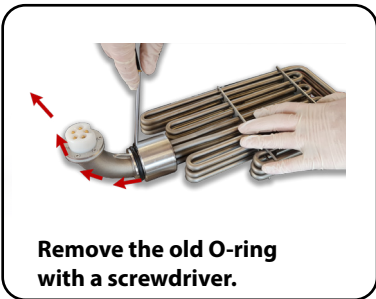
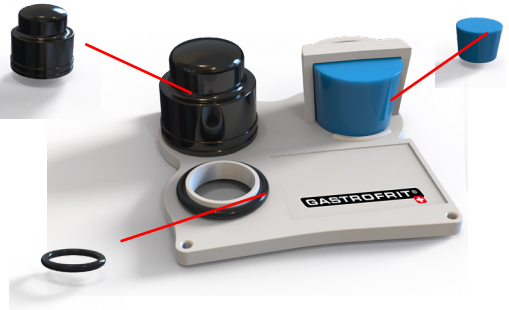

Pressure filter

The Mirooil filter, pressure filter with sealing ring (Art. No. 501000.118) must be emptied and cleaned after each filtering process. The filter must be replaced when worn. Otherwise the filter suction pump will be affected or the suction nozzle clogged.

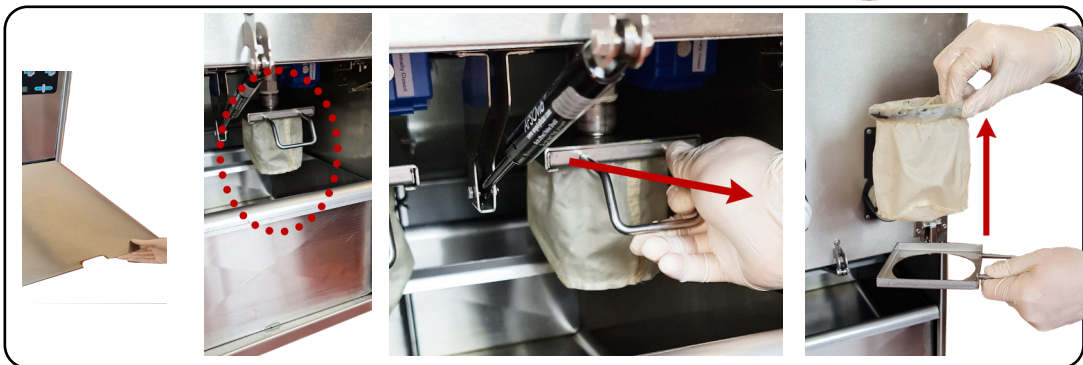

Keypad deep fryer

Watch Volume / Automatic basket lift
optional

Clean System / Automatic filtration
optional

On / off switch

Oilcheck system / Q-sensor oil
optional

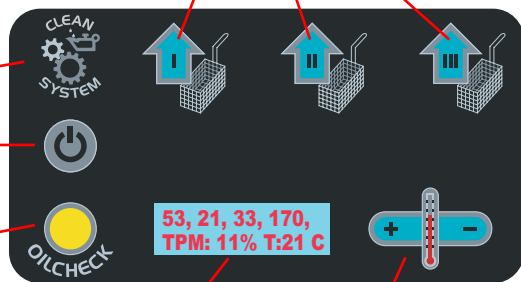

Digital display

Temperature
or menu control + / -

Operational readiness

- Check the existing voltage and current fuse protection with the type plate. If the security is sufficient, you can start the cooking process.
- Open the cover (fire protection) on the device and insert it at the back
- Remove the basket
- Close the drain cock
- Fill in oil up to the filling mark

Operating

Call up the parameter menu

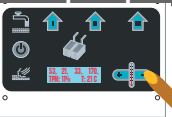

If the device is in the OFF state, you can switch to the parameter menu by pressing the „plus“ or „minus“ button for 10 seconds.

Change parameter pages



The various parameter pages can be called up with the „Clean System“ button.

Change parameters

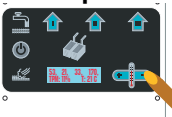

The parameters can be changed with the „plus“ and „minus“ buttons.

Quit the parameter menu and save the new values.

To exit the parameter menu, press the „ON / OFF“ button. The changed values are saved and are retained even in the event of a power failure.



Example parameter menu



Changeable parameters

1. Sound-Level:
The volume of the buzzer can be changed between 0 (off) and 10 (very loud).
2. Standby time:
The standby time for the TW and the deep fryer can be set between 5 and 120 minutes. If the „-“ button is pressed for 5 minutes, the standby mode is switched off (Off).
3. Standby temperature:
The standby temperature for the TW can be changed between 30 and 80 °C and for the deep fryer between 30 and 150 °C.
4. Monitoring drying cycle:
After switching on, the temperature must not rise more than the set temperature difference (10-80 °C) for the first 60 seconds. If the temperature rises more, an error message is output (too little water / oil) and the control goes into the off state.
5. Temperature limit for the clean function (deep fryer only):
The limit temperature of the deep fryer can be set between 30 and 170°C. If the temperature is higher than this set temperature, the clean function is blocked.
6. Automatic filtration (deep fryer only):
Automatic filtration can be activated on the deep fat fryer. The programmed times are called up one after the other and the oil pump and the ball valve are automatically operated. If the clean button is pressed again, the active time is canceled. If the On / Off button is pressed, the automatic filtration is canceled.
7. Time (Time1) for automatic emptying (deep fryer only):
During this time
8. Time (Time 3) for automatic filling (deep fryer only):
During this time the ball valve is closed and the pump is active. The tub fills with oil.
9. Monitoring oil quality (deep fryer only):
The oil quality (TPM) of the deep fat fryer can be set between 10 and 40%. If this value is exceeded, a program (I-III) cannot be started. With the setting OFF, a program can always be started.
10. Monitoring salt water (only TW):
With the TW, the monitoring of the salt content (salinity alarm) can be set between 1 ‰ and 30 ‰ (default values: low = 8 ‰ and high 12 ‰). If this value is not reached (too little salt), after the set time (Salinity-Alarm Time: 1-60 seconds) an acoustic alarm (Salinity-Alarm-Sound) occurs and the background color changes its color to purple.

If there is too much salt, the background lighting changes to blue and an acoustic alarm (Salinity alarm sound) may sound. If the salt content changes back into the valid range, the background lighting changes to the normal color and the acoustic alarm is ended. The "+" and "-" key combination displays the salt content and pressing the "+" key the alarm is re-set again. Interval of the acoustic alarm: 10s. Different tone sequences when exceeding or falling below the limit value.

11. Salinity-Alarm (Sound):

- a. Off: no acoustic alarm
- b. On: acoustic alarm when the TW is switched on
- c. Temp: acoustic alarm when the TW is switched on and the temperature is > 90 °C
- d. Lift: acoustic alarm if TW is switched on, temp. > 90 °C and a HUB is active.

12. Interval time for contactor control (only with relay operation, not with SSR):

The interval time can be set from 2 to 60 seconds. The following settings then apply:

- a. Interval time: 2-9 sec., If the temperature deviates by > 1 °C, heating takes place.
- b. Interval time: 10-19 sec., If the temperature deviates by > 2 °C, heating takes place.
- c. Interval time: 20-60 sec., If the temperature deviates by > 4 °C, heating takes place.

13. Dry run monitoring:

The drying cycle monitoring can be switched on or off.

14. Demo-Mode:

If the demo mode is activated (20-240 seconds), a key press is simulated after the set time. First a key press „PROG1“ and the next time a key press „PROG3“ is simulated. The programmed time will run down normally and then the time (demo mode time) will

be waited until the next key is simulated. A program can be canceled at any time. This demo mode is intended for a long-term test or for a demonstration during presentations.

15. ABCD bus (Sicotronic energy management):

The ABCD interface for energy management can be switched on or off via the menu (changeable parameters) for controls that do not have a ball valve (SW2-3) or a lifting motor (SW1-8). If the control has neither a ball valve nor a lift motor, the lift motor 2 OPEN relay is used as output A.

When the ABCD bus is activated (changeable parameters) it is not monitored whether a ball valve or lifting motor has been activated with the DIP switches or not.

16. Time for the HUB motor movement:

Die Zeit kann zwischen 3.00 und 10.00 Sekunden eingestellt werden. Der DIP-Schalter 50/60 Hz hat keine Funktion mehr. Diese Option ist nur ab Version 8.72 möglich

17. When the ABCD bus is activated (changeable parameters) it is not monitored whether a ball valve or lifting motor has been activated with the DIP switches or not.

18. Time for the HUB motor movement:

The time can be set between 3:00 and 10:00 seconds. The 50/60 Hz DIP switch no longer has any function. This option is only possible from version 8.72

ABCD interface for Sicotronic EAM-N module:

A (Pin 2)	Relay ball valve (230VAC)	Gastro8 is switched on Relay lift motor 2 open (230VAC)
B (Pin 12)	Relay heating (230VAC) Ext. Relais/contactor	Heating should be switched on
C(*)	Ext. Relais/Schütz (230VAC)	The relay contact must be the control line from the SSR or interruptor contactor
D (Pin 13)	Neutral conductor (N) PE (Pin 15)	Protective conductor

Parameter Matrix

Configuration overview parameter menu

TW	Fritteuse	Text	Min. Wert	Max.	Default
X	X	Sound-Level	0 = Off	10	1
X	X	Standby-Time	Off / 5 min.	120 min.	45 min.
X		Standby-Temperatur	30°C	80°C	50°C
	X	Standby-Temperatur	30°C	150°C	130°C
X	X	Power-On temperature difference	10°C	80°C	15°C
	X	Level Clean-Temperatur	30°C	170°C	150°C
	X	Oillimit Hub OFF	Off / TPM 10	TPM =40	TPM =5%
	X	Auto. Filtration	Off	On	Off
	X	Auto. Emptying (Time 1)	5 sec.	500 sec.	180 sec.
	X	Auto. circulation (Time 2)	5 sec.	500 sec.	180 sec.
	X	Auto. Filling (Time 3)	5 sec.	500 sec.	180 sec.
X		Salinity-Alarm (Low)	1‰	30‰	8‰
X		Salinity-Alarm (High)	1‰	30‰	12‰
X		Salinity-Alarm (Time)	1 sec.	60 sec.	10 sec.
X		Salinity-Alarm (Sound)	Off	On	On
X	X	Relais-Time	2 sec.	60 sec.	20 sec.
X	X	Drying cycle	Off	On	On
X	X	Demo-Mode-Time	Off / 20 sec.	240 sec.	Off

Top up with deep-frying oil

1. Close the drain cock.
2. Attention with the option „electrical drain cock“ the drain cock is always closed as soon as the device is de-energized. To operate the electrical drain valve, read chapter 7.4 Electrical ball valve (drain).
3. Fill in your preferred oil. Attention, do not exceed the maximum mark!

Switching on the deep fryer

- Press the key . In deep fryers, the contactor switches on audibly and the display shows 170 ° C and flashes every second.

Programming the parameters

- **Kitchen timer for deep fryers (Clean System button)**



In the deep-frying models without the Watch Volume option, a kitchen timer can be programmed on the Clean System button. A time can be programmed by pressing the Clean System button and holding it for 10 seconds. The time value can be increased with the “plus” button and decreased with the “minus” button. The value is saved by pressing the Clean System button again. Briefly pressing the Clean System button starts the kitchen timer. After the set time has elapsed, a warning signal sounds at the specified volume..

- **Program the pump filtration time (Clean System button)**



You have the option

- Clean System (pump) bought so that a filter run time can be set when the machine is switched off.
- Press the Clean System button for 10 seconds.



The time is now adjustable. The time can be adjusted with the buttons and. The value is

saved by pressing the Clean System button again.

- **Programming the watch volume on deep fryers**
- Fill the basket with any amount of frying.
- Press program buttons I / II / III each for at least 10 seconds.

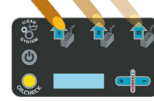

- The display flashes until the temperature is reached.
- Wait until the temperature is reached. Please immerse the basket manually. With the automatic lifting device, the basket will lower itself. If you want to produce quickly without waiting for the deep fryer to first reach the TARGET temperature, this can be set in the options. The temperature then has no influence on the cooking process. The disadvantage is a more irregular quality
- When the quality is reached, remove the basket and press the same program button again. With the lifting device option, only the program button needs to be pressed. The basket moves up automatically.
- The respective program is now programmed
- **Programming the time for deep fat fryers without watch volume (I, II, III and IV)**
- Programmtasten I / II / III jeweils mindestens 10 Sekunden drücken.

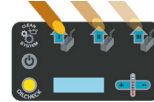

- The time to be set appears on the display.
- Set the time with the „plus“ and „minus“ buttons.
- Press program buttons I / II / III again each time
- The respective program is now programmed over time and can be used

Temperature settings

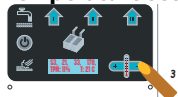

- The target value of the temperature can be increased with the „+“ key and decreased with the key.
- As long as the value is flashing, the specified temperature has not been reached.

Query current temperature



- Simultaneously press the „plus“ and „minus“ buttons
- The current measured temperature is displayed. The measurement is carried out with a PT-1000 and has an accuracy of +/- one degree Celsius.
- Caution Fryers with contactor control overshoot when they are heated up for the first time.

Frying

1. Press the on / off button.



2. Set the thermostat to the desired temperature

3.  **Attention: The switched on deep fryer is only permitted in supervised operation!**

4. Solltemperatur blinkt..

5. As soon as the temperature is reached, the flashing stops. For deep fat fryers with watch volume / automatic basket lift, program buttons 1, 2 and 3 are programmed with an emergency program of approx. 4 minutes at 180 ° C - 182 ° C.



6. Place the food to be fried in the basket. (¼ fill)
7. Shake well before dipping deep-frozen food
8. Place the basket in the deep-frying bowl.
9. As soon as the fried food has the desired brownin

reached, lift the basket and hang it on the brack to drain.



Warning:

To avoid the risk of splashing and burns, fill in the new deep-frying medium slowly and carefully when topping up with oil. Old and dirty oil is easily flammable and promotes foaming over!

Reset



To restart the controller, the „on / off“ and „clean system“ buttons must be pressed simultaneously.

Oil filter system (Clean System)

Occasional filtration can extend the shelf life of the oil by filtering out tiny particles using a microfilter.

Manually



1. Switch off the device, press the gray on / off button..



2. Insert the enclosed Mirooil filter below the frying basin and empty the oil (max. 180 ° C) back through the filter into the basin.
3. By opening the drain cock, the oil reaches the collecting container
4. Important! Close the drain cock again!!
5. Make sure that the minimum fill mark is reached. Otherwise top up with fresh oil.



Attention! You are handling hot oil =>Risk of burns!

Semi-automatic: pump / safety drain

1. Switch off the device, press the gray on / off button..



2. The pump only works if the deep fryer has been switched off beforehand using the gray button. The display shows as a control:



3. Press the Clean System -> Display:



Filter ok?
Ja='+' Nein='-'

4. Insert the enclosed microfilter into the frying basin. To do this, you must first open the service door at the bottom.

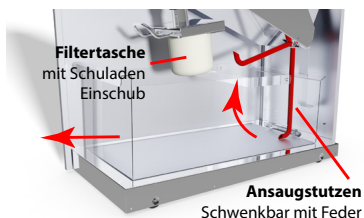

Press +

Abfluss öffnen?
Ja='+' Nein='-'

- 5.

Press +

Achtung Öl!
Bitte warten...

6. The safety drain valve opens automatically. ATTENTION: hot oil!
7. **If not available:** By opening the drain cock, if the automatic safety drain option is not available, carefully open the red ball cock (toggle) below the deep-frying basin. The oil (max. 180 °C) flows through the filter into the collecting container.



Attention!

You are handling hot oil => risk of burns!

Important! Close the drain cock again!

Close the service door.

8. Wait until all the oil is in the collection container. Since the Mirooil filter is extremely fine-meshed, the oil should be at least 90 °C hot.
9. This message appears after two minutes:

Press +

Ölpumpe starten?
Ja='+' Nein='-'

10. The pump is activated. The oil is automatically pumped into the pan. (Note that the heater has been plugged in.)

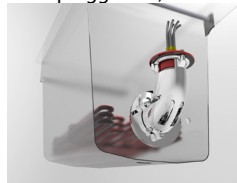

The pump runs out for the programmed time. By pressing the Clean System button again, the pumping process is canceled and the pump switches off.



Automatic oil filtration

The oil can be filtered automatically with a pump and safety drain (electric ball valve)..



Press the Cleansystem button to enter the new menu. You are now menu-guided through the processes. Follow the instructions on the display! (Note that the oil temperature is between 90 °C and 180 °C).

Watch Volume with automatic

Term „Watch volume“:

Specify the quality of the product once, always achieve the same quality afterwards, regardless of the amount of fried food. The whole calculati-

on is of course only reliable if you always use the same products. (e.g. always Bintje potatoes)

Automatic basket lift

1. The automatic basket lifting function automatically lifts the frying basket out of the oil when the quality is reached.
2. As soon as the quality has been programmed, the relevant program button can be pressed. For deep fryers you have 3 programs which can be programmed.



3. The program call can be canceled at any time. Press the same program key again and the process will be canceled.
4. When the deep fat fryer is switched on, the lifting motor extends automatically. (except for the fat melting cycle, only at 80 °C)
5. When it is switched off, it retracts accordingly in order to be able to close the lid.

Energy optimization

There are two different types of energy optimization controls. Energy optimization light and energy optimization with ABCD interface.

With the energy optimization light, a relay (NC contact) must be provided on site. You can request detailed documents from us.

Service functions

Change O-rings Heater can be removed

Description and function

Please ensure, however, that the O-ring (black ring) cannot be damaged by knives or other sharp objects. A defective seal means that the heater is no longer tight and the oil or grease leaks and drips into the collecting container. The removable heating element is provided with an O-ring (see picture) which prevents oil from leaking into the interior of the fryer. The permanent heat load can cause the O-ring to become brittle and its function can only be of limited use. This sealing ring can be exchanged easily. Manufacturer's recommendation: Replace this seal annually. With a LongLife maintenance contract or LongLifePlus, we as the company Gastrofrit® AG will carry out this measure. You can also instruct the manufacturer to have these replaced during a six-monthly check. You can order the O-ring or more detailed information on the maintenance contracts by calling +41 71 855 8070 or email: info.gastrofrit.ch

Remove the old O-ring:



New O-ring :

**„By hand“
„without force“**

put over the plug:



Possible malfunctions

Safety thermostat / fire protection triggers mechanically

The device no longer heats up, but the display flashes. In addition to electronic temperature monitoring and electronic fire protection, our deep fryers also have mechanical fire protection. If the electronics do not function properly and the oil / fat overheats or the oil level is too low, the safety thermostat responds at a temperature of > 230 °C and automatically interrupts the heating circuit. A red reset button is located on the cover on the fitting box in the interior of the control. To do this, an experienced person must unlock the control with the key. This can be pushed up and thus reset. If the safety thermostat switches off several times, service must be requested.

Machine has no function, display dark

- check the fuses of the electrical supply line.
- is the plug inserted?
- is the main switch switched on (on site and device)?
- is the safety thermostat activated?

No success? call our service department
0041 71 855 8070, or email: info@gastrofrit.ch

Warning message Error 1, PT-100 / PT-1000

The machine does not receive any current temperature or has an interruption to the PT-1000 sensor and therefore cannot switch on. (Fire hazard)

- Check the plug contacts to the PT-1000
- Ohm measured value PT-1000 at 25 ° C ->R = 1.008 kΩ see table in Appendix 3

Maintenance and customer service

In the event of malfunctions, contact Gastrofrit AG in Rorschach, Switzerland, Call. 0041 71 855 8070. The device may only be repaired and connected by trained specialists. Note: (only for repair service with Gastro-frit® training):



Attention! All mains circuits must be switched off before access to the connection terminals.



Wichtig: Bitte geben Sie bei jeder Meldung an die Servicestelle den Apparatetyp und die Apparatenummer an (Innenseite der Türe).

Es ist empfehlenswert, den Typ und die Nummer nachfolgend einzutragen. Regelmäßige Wartung kann die Lebensdauer Ihres Gerätes verlängern.

maintenance

Important: Please state the type of device and the device number (inside of the door) with every report to the service point.

It is advisable to enter the type and number below. Regular maintenance can extend the life of your device

cleaning

devices

1. Switch off the device, press the on / off button
2. Open the drain cock and drain the oil into the collecting container. Never empty the used oil into the sewage system; dispose of it properly!
3. Place the empty collection container back in the device.
4. In order to clean the interior of the deep fat fryer, the conical plug (item no. 305010.050) must be plugged into the heating lead-through.

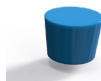

5. Please insert the cone plug in advance! (See page 5)
6. The interior of the deep fryer of the deep fryer is cleaned by boiling water with a degreasing detergent in the device. Use the Gastrofrit deep fryer cleaner. Only fill the water up to the maximum oil / water level.
7. Switch the device off again. Press the on / off button. Remove the heating element. (according to point 9.2) With standard models, pull up the heater and turn it.
8. The opening of the 2nd generation of the heater must be sealed watertight with a rubber stopper.
9. Remove dirt with a brush. (Do not use a steel brush)
10. Drain the dirty water into the empty collecting container
11. Rinse thoroughly and dry out
12. Remove the rubber stopper again.
13. Place the heating element back in the device. (according to point 9.2) dry any wet power plugs well before re-use.

The deep fryer is ready for the next use again!
All sheets are made of stainless steel and can be treated with a commercially available chrome steel cleaner.

Heating elements

Daily cleaning of the heater protects the oil and the performance of the heater is maintained.

Heaters plug in

The clip-on heating element can be removed from the deep fryer and washed or placed in the dishwasher.

1. Turn off the deep fryer. Press on/off Bottom



2. Empty the frypot. There must be no contents (oil, fat or cleaning water!) in the cooking basin.
3. Let the heating cool down to 35 °C (hand warm).
4. Removal or insertion is easy, as shown in the photo. Without great force. Do not try it by force, it will certainly not lead to success!



5. The whole process takes place in a round, harmonious movement (due to the design). Make sure that the seal on the heater disappears in the hole. Press the heater lightly against the wall of the pan.
6. We recommend cleaning the heater in an appliance dishwasher. To do this, the protective cap supplied (item no. 501000-812) should be slipped over the plug head.



7. In order to clean the interior of the deep fat fryer, the conical plug (item no. 305010.050) must be plugged into the heating lead-through.

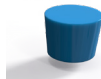

Please insert the cone plug in advance! (See page 5)

Note:

If the heater is not used or not used correctly, the device cannot be switched on or switched off serve. (only applies to 1st gen.)

Attention:

After each cleaning, the white plug must be cleaned of possible water droplets. It is best to blow out with compressed air! Always place the 2nd generation heater in the same deep-frying basin! (construction-related)

Heating standard

The heating element can be pulled out and rotated. The difference to the 2nd generation is that these are not removed.

1. Turn off the deep fryer. Press on/off Bottom



2. Empty the frypot. There must be no contents (oil, fat or cleaning water!) in the cooking basin.
3. Let the heating cool down to 35 °C (hand warm).
4. Pull out the heater and turn it slightly to the left
5. The vat can now be cleaned.

Note:

If the heater is not used or not used correctly, the device cannot be switched on or operated.

Hazard warnings

- Under no circumstances may the deep fat fryer be operated without fat or oil. There is a risk of fire if the level falls below the lowest level!
- The heater must not be removed during operation.
- Entering too large quantities and too wet food will increase the foaming of the oil and reduce the quality!
- In the event of a grease or oil fire, the device cover must be used to fight the fire. In the event of fire, place the lid on the basin immediately! Turn off the main switch and pull out the power plug!
- There is a risk of splashing and burns!
- The pump must not be touched from below during operation.
- The power plug must be accessible at all times in order to disconnect the machine from the power.
- If the connection cable is damaged, it must be replaced by the manufacturer.
- This device is not intended to be used by persons (including children) with limited physical, sensory or mental capabilities due to lack of experience and / or lack of knowledge. Unless they are supervised by a person responsible for your safety or have received instructions from them on how to use the device.

Preventing, fighting oil fires

- Attention, never fight oil or grease fires with water!
- Suitable equipment must be available to fight an oil or grease fire. Such as fire extinguishers, fire blankets or fixed extinguishing devices (Halon fire extinguishers)
- Old, soiled oil / fat is more easily ignitable and promotes foaming.
- Refilling cold oil / fat with hot oil / fat is very dangerous!

Moving deep fryers

Moving the deep fryer with hot oil, fat in the basin or in the collecting container is not permitted! Likewise, the removal of the collecting container filled with hot oil or fat. Let the oil or fat cool down to at least 60 ° C.

Extended display

This display is only intended for service cases and not for the customer!

With the extended display, the target and actual values of the temperature, calibration parameters and the heating power can be viewed on various display pages.

Switch to the extended display:

To switch to the extended display, the

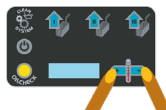

keys, must be pressed simultaneously for a short time and the current oil temperature will appear on the display. During this display, the „plus“ key must be held down and the first page of the extended display appears.

If you want to view the data from the oil sensor or salt sensor, the „minus“ key must be pressed. Change display pages: To select the other display pages, briefly press the „plus“ button. Exiting the extended display: Press the „minus“ key.

Target temperature: „>“ means that the temperature has not yet been reached:

S: 167°C >I: 164°C
H: 50 % 164.2°C

-"H:": Heating output, actual temperature

Temperature and heating power:

31.6°C 160.9°C
T: 3265 Pt: 7240

Temp. Circuit board Temp. Pt1000-Sensor
Total of 8 measurements (max. 8192 -> 4.1 Volt)

Temperature display:

62.0°C 195.0°C
1. 5559 2. 7800

Ref. resistance 1240R Ref. resistance 1740R
Total of 8 measurements (max. 8192 -> 4.1 Volt)

Display pages with the „minus“ key:

53, 26, 33, 152,
TPM: 5% T: 26°C

Data from the oil sensor are displayed.
Oil quality 3-30% temperature from the oil sensor.

Oil sensor:

Salinity 95.2°C
10.35%. 0.56mS

Sensor data are displayed. Actual temperature
Salt content in per mille conductance

Tastenbelegung im Testmode



The various test states can be called up with the key. For some tests, entries can still be made, this is done



with the buttons and button „plus“ and „minus“. To exit test mode, press the „on / off“ button.

Test Pages:

Keyboard test:

```
P1:X P2:X P3:X  
P4:X OL:X UL:X
```

Tasten I-IV und die Tasten CleanSystem /
Wasserfüllung und Oilcheck / Abschwemmung

Temperature test:

```
I.Temp: Pt1000  
26.3°C 96.7°C
```

Temperatur Temperatur
Leiterplatte Pt1000-Sensor

DIP switch and relay test:

```
XXXXXXXXXXXXXXXXXX  
XXXXXXXXXXXXSwitch:0
```

DIP-Schalter1 (1-8) DIP-Schalter2 (1-8)
Relais1 – Relais 7 – SSR-Ausgang Endschalter

Electric ball valve (safety drain valve) test:

```
Ball-valve:open  
Time: 5.1 sec.
```

Open/Close mit der Taste „+“
Zeit stoppen mit der Taste „-“

Oil sensor test:

```
53, 26, 33,152,  
TPM: 5% T: 26°C
```

Daten vom Ölsensor werden Anzeigt.
Ölqualität 3-30% Temperatur vom Ölsensor

Salt sensor test:

```
Salinity 95.2°C  
10.35%. 0.56mS
```

Sensordaten werden Anzeigt. Ist-Temperatur
Salzgehalt in Promille Leitwert

Summer und Sound Test:

```
Vol. Freque. Ton  
* 0 4006Hz 1
```

Tasten I – III: Lautstärke, Frequenz oder Tonfolge
Taste „+“ und „-“: Um den Wert zu verändern.

LCD Backlight Test:

```
ROT GRUN BLAU  
* 8 10 10
```

Tasten I – III: Verschiedene Farben auszuwählen.
Taste „+“ und „-“: Um den Wert zu verändern.

Calibration test:

```
*5587 7840 Pt1  
5580 7800 6979
```

Tasten I – III: Ref. Wider. Ref. Wider. PT1000
bei 62°C bei 195°C Sensor

DIP Switch / Connection scheme

Dip Switch:

SW1		
F	Friteuse	
P	Pastakochoer	OFF ON
1	Modell	Friteuse Pasta
2	Standby	aus ein
3	Sound	aus ein
4	F Oilcheck	aus ein
4	P Salzcheck	aus ein
5	F Fettschmelz	aus ein
5	P Wassermenge	15-20L 20-25L
6	F Generation	Standard 2te
6	P Generation	ohne Hub mit Hub
7	F Pumpe	aus ein
7	P Magnetventil	aus ein
8	Hubmotoren	ein aus

SW2		
		OFF ON
1	Englisch	aus ein
2	Französisch	aus ein
3	Kugelhahn	aus ein
4	Netz 60Hz	aus ein
5	SSR	aus ein
6	Heizen WatchVolume	aus ein
7	-	aus ein
8	-	aus ein

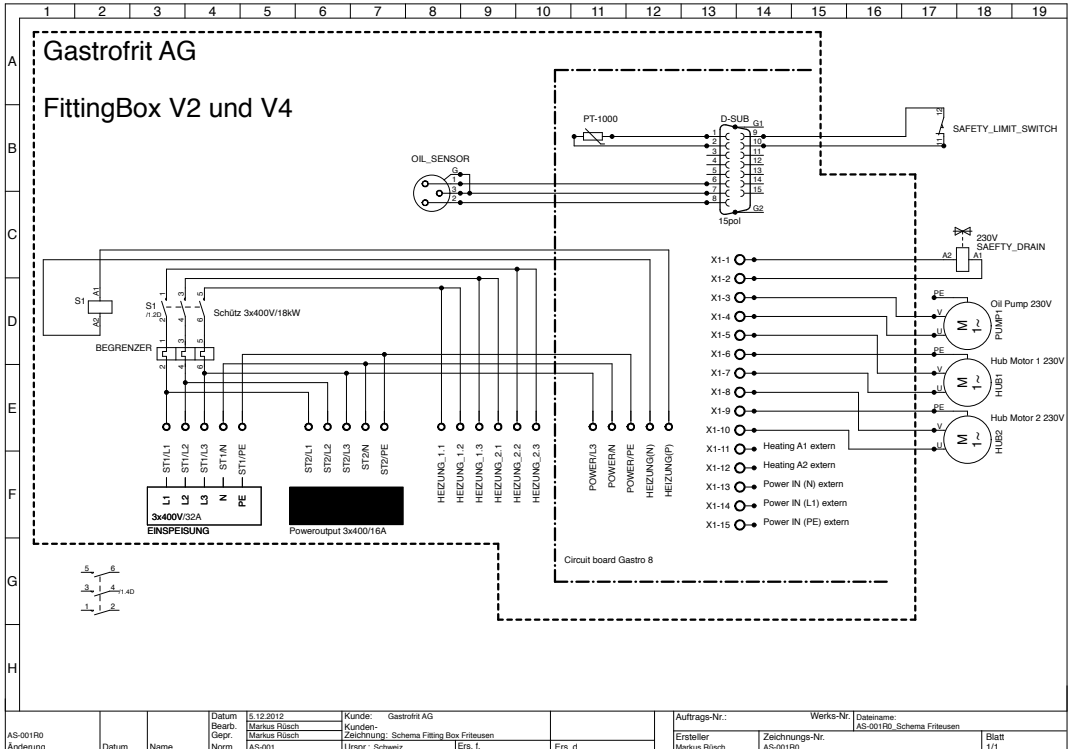

AS-001R0	Datum: 5.12.2012	Kunde: Gastrofrit AG	Ersteller: Markus Rüschi	Zeichnungs-Nr.: AS-001R0	Blatt: 1/1
Änderung	Name: Markus Rüschi	Kunden: Markus Rüschi	Zeichnung: Schema Fitting Box Friteusen	Werk-Nr.: AS-001R0	Datenname: AS-001R0_Schema Friteusen
Papierrand	Datum: AS-001	Urspr.: Schweiz	Ers. d.:		

Prinzipschaltbild für SICOTRONIC-Anschluss mit einem internen Geräteheizkreis

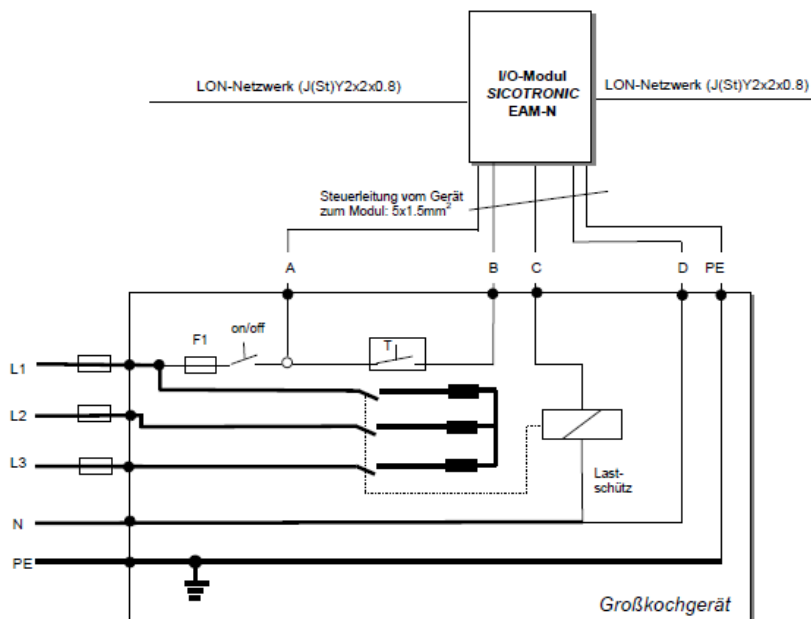

Funktionsprinzip: Ein Regelkreis des EAM-N

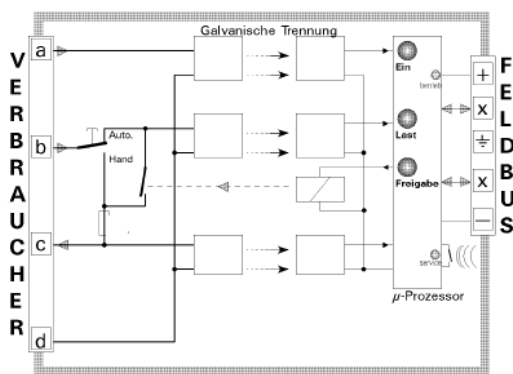

Beschreibung der Anschlüsse:

Klemme	Funktion	Signal	Typischer Anschluss
A	Eingang	Verbraucher ist eingeschaltet	Vom Verbraucher-Einschalter
B	Eingang	Verbraucher fordert Leistung	Vom Verbraucher-Thermostat
C	Ausgang	Zuteilung der Leistung (Signal "b" wird auf "c" wieder ausgegeben)	Zum Lastschütz
D	-----	Gegenpotential zu "a" und "b"	Null-Leiter

Connection diagram electronics version Gastro 8

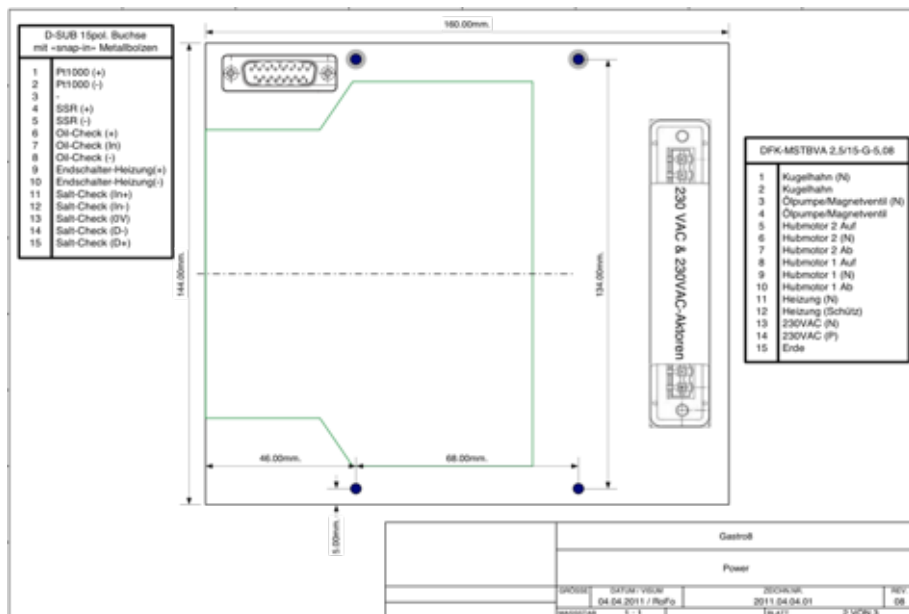
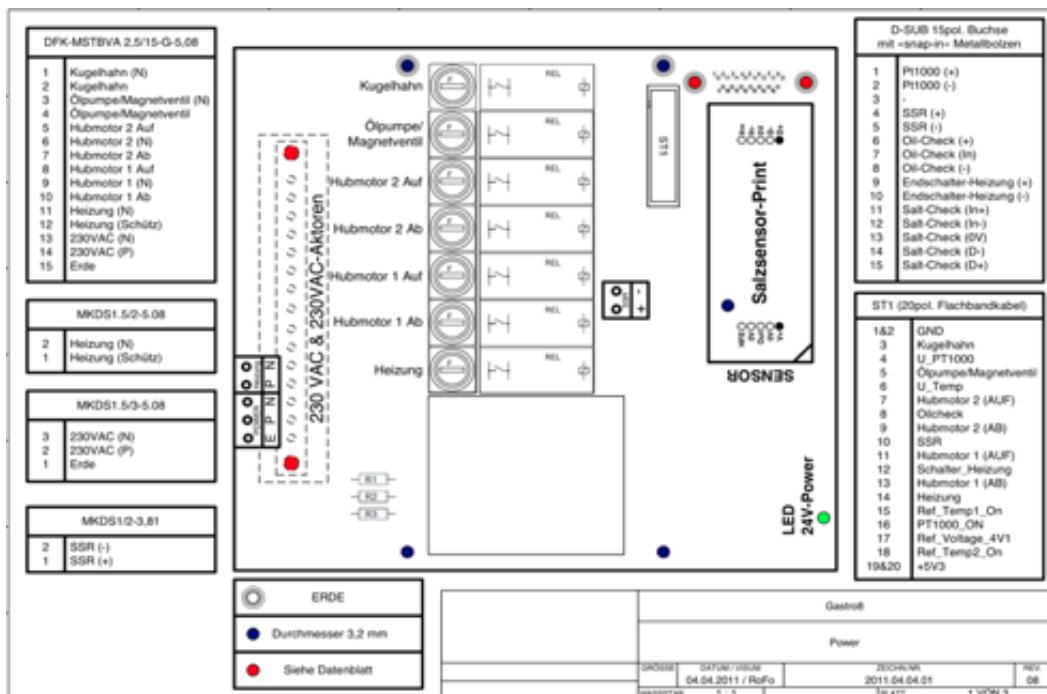

Modell (Fritteuse)	Standby	Sound	Ölcheck	Fettschmelz	Generation (Standard / 2.Generation)	Pumpe (für CleanSystem)	Ohne Hubmotor (Korbhebeautomatik)	Englisch	Französisch	Kugelhahn (Entlerung mit Taste CleanSystem)	Netz 60Hz	SSR	Watch Volume: Wird erst gestartet, wenn Temp. ok	Watch Volume: Prog. Temp. wird übernommen	Timer statt Watch Volume Programm (Tasten 1-3)	Timer bei Taste Clean-System (J = Ja, N = Nein)	*Endschalter Heizung (J = Ja, N = Nein)	Abglühen der Heizung (J = Ja, N = Nein)	Programm bei Tasten I – III (J = Ja, N = Nein)	**Tasten-Layout (1-3)	Bezeichnung
1	2	3	4	5	6	7	8	1	2	3	4	5	6	7	8						
0	X	X	0	X	0	X	1	X	X	X	X	X	0	0	x	J	J	J	-	1	Fritteuse Standard
0	X	X	0	X	0	X	1	X	X	X	X	X	0	0	x	J	J	J	-	1	Fritteuse Electronic
0	X	X	0	X	1	0	1	X	X	X	X	X	X	X	0	N	J	J	J	2	Fritteuse Elektronik (ohne Clean System, ohne Korbhebeautomatik)
0	X	X	0	X	1	1	1	X	X	X	X	X	X	X	0	N	J	J	J	2	Fritteuse Elektronik (mit Clean System, ohne Korbhebeautomatik)
0	X	X	0	X	1	1	0	X	X	X	X	X	X	X	0	N	J	J	J	2	Fritteuse Elektronik (mit Clean System, mit Korbhebeautomatik)
0	X	X	1	X	1	0	1	X	X	X	X	X	X	X	0	N	J	J	J	3	Fritteuse Elektronik (ohne Clean System, ohne Korbhebeautomatik)
0	X	X	1	X	1	1	1	X	X	X	X	X	X	X	0	N	J	J	J	3	Fritteuse Elektronik (mit Ölsensor, mit Clean System, ohne Korbhebeautomatik)
0	X	X	1	X	1	1	0	X	X	X	X	X	X	X	0	N	J	J	J	3	Fritteuse Elektronik (mit Clean System, mit Korbhebeautomatik)

**EU/UE KONFORMITÄTSERKLÄRUNG
DECLARATION OF CONFORMITY
DÉCLARATION DE CONFORMITÉ****www.gastrofrit.ch****info@gastrofrit.ch****Tel.: +41 71 855 80 70**Wir
We
Nous

(Name des Anbieters) (supplier's name) (nom du fournisseur)

GASTROFRIT AG, Weiherstrasse 11, CH-9400 Rorschach

(Anschrift) (address) (adresse)

erklären in alleiniger Verantwortung, dass das Produkt
declare under our sole responsibility that the product
déclarons sous notre seule responsabilité que le produit**Gastrofrit Fritteusen****OLFO**(Bezeichnung Typ oder Modell), Los-, Chargen- oder Seriennummer, möglichst Herkunft und Stückzahl)
(title and/or number and date of issue of the standard(s) or other normative document(s))
(titre et/ou no. et date de publication de la (des) norme(s) ou autre(s) document(s) normatif(s))auf das sich diese Erklärung bezieht, mit der/den folgenden Norm(en) oder normativen
Document(en) übereinstimmt.to which this declaration relates is in conformity with the following standard(s) or other
normative document(s)auquel se réfère cette déclaration est conforme à la (aux) norme(s) ou autre(s) document(s)
normatif(s)**IEC 60335-1: 2010;****EN 55014-1: 2006+A1:09+A2: 11;****IEC 60335-2-37: 2002+ Cor.: 2007+ A1:2008+ A11: 2012****EN 55014-2: 1997+A1:01+A2:08;****IEC 60335-2-47: 2012;****EN 61000-3-2: 2006+A1: 09+A2: 09****EN 61000-3-3: 2013**(Titel und/oder Nummer sowie Ausgabedatum der Norm(en) oder der anderen normativen Dokumente)
(title and/or number and date of issue of the standard(s) or other normative document(s))
(titre et/ou no et date de publication de la (des) norme(s) document(s) normatif(s))

Gemäss den Bestimmungen der Richtlinie(n);

Following the provisions of Directive(s);

Conformément aux dispositions de(s) Directive(s)

(falls zutreffend) (if applicable) (le cas échéant)

Richtlinie 2006/95/CE; Richtlinie 2006/42/CE; Richtlinie 2004/108/CE(Ort und Datum der Ausstellung)
(Place and date of issue)
(Lieu et date)

Rorschach, 01.01.2021

(Name und Unterschrift oder gleichwertige
Kennzeichnung des Befugten)
(name and signature or equivalent marking of
authorized person)
(nom et signature du signataire autorisé)Alexander Schlegel
Geschäftsführer